

IN002PURE+

Pure+ Badkamer / Salle de bain / Badezimmer / Bathroom

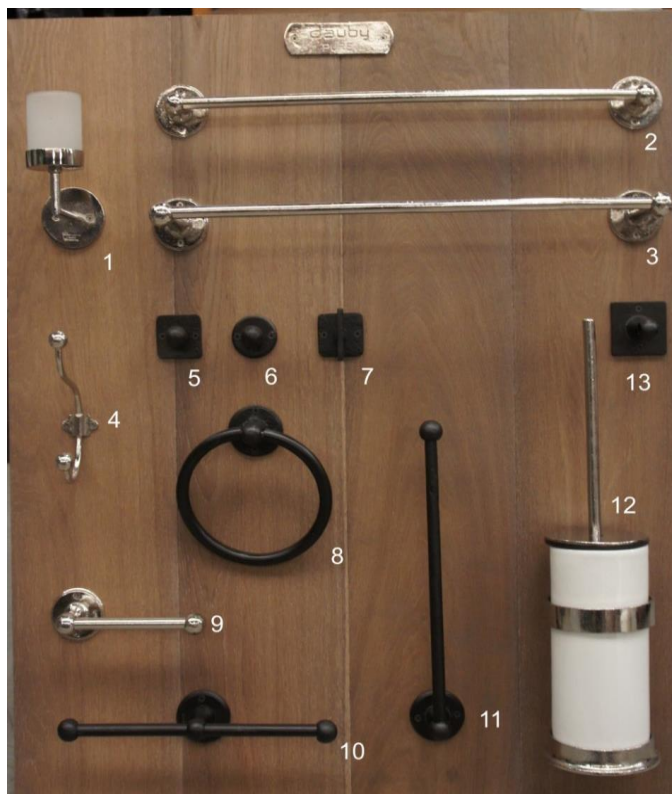

Opgelet!

- ° De prijzen zijn steeds BRUTO, exclusief BTW.
- ° De gemarkeerde regel is het artikel dat op uw paneel staat.
- ° Let goed op de eenheid van de artikels:

~ st./pc. = per stuk, dus los artikel

~ paar/paire = samengesteld artikel



Attention!

- ° Les prix sont brut, TVA exclusif.
- ° La zone marquée est l'article sur votre panneau.
- ° Faites bien attention de l'unité des articles:

~ st./pc. = par piece

~ paar/paire = par paire



Achtung!

- ° Alle Preise sind Brutto Preise ohne MwSt.
- ° Die markierte Linie ist das Artikel auf Ihrem Display.
- ° Bitte beachten Sie die Verpackungseinheit: Per Stück <-> Per Paar



Attention!

- ° These are gross prices, without VAT.
- ° The line that is marked correspond to the article on your panel.
- ° Pay attention to the quantity of the articles:

~ st./pc. = per piece,

~ paar/paire = per pair, combined article





Pure [®] Plus	Uitvoeringen Finitions Ausführungen Finishes	NL	FR	D	E
	VO	Verouderd ijzer	Fer vieilli	Dunkel Eisen	Aged Iron
	WB	Wit Brons	Bronze blanc	Weiss Bronze	White Bronze
	WBS	Mat Wit Brons	Bronze blanc satiné	Weiss Bronze satiniert	Satin White Bronze
	RB	Ruw Brons	Bronze brut	Rohe Bronze	Raw Bronze
	RM	Ruw Metaal	Métal brut	Rohes Metall	Raw Metal

Art°	Eenheid Unité Einheit Unit	REF.	€ excl. BTW hors TVA ohne MwSt. w/o VAT
------	-------------------------------------	------	---

						
2	10001	St. / Pc.	Holder short brackets	1000mm	VO	88,53
	10002	St. / Pc.		1000mm	WB	132,23
	15348	St. / Pc.		1000mm	WBS	132,23
	13817	St. / Pc.		1000mm	RB	132,23
	15347	St. / Pc.		1000mm	RM	88,53
	H65mm					

						
	11823	St. / Pc.	Holder short brackets Square	1000mm	VO	88,53
	11824	St. / Pc.		1000mm	WB	132,23
	15350	St. / Pc.		1000mm	WBS	132,23
	13835	St. / Pc.		1000mm	RB	132,23
	15349	St. / Pc.		1000mm	RM	88,53
	H65mm					

						
3	10707	St. / Pc.	Holder long brackets	1000mm	VO	98,37
	10708	St. / Pc.		1000mm	WB	167,74
	15352	St. / Pc.		1000mm	WBS	167,74
	13818	St. / Pc.		1000mm	RB	167,74
	15351	St. / Pc.		1000mm	RM	98,37
	H150mm					

						
	11825	St. / Pc.	Holder long brackets Square	1000mm	VO	98,37
	11826	St. / Pc.		1000mm	WB	167,74
	15354	St. / Pc.		1000mm	WBS	167,74
	13836	St. / Pc.		1000mm	RB	167,74
	15353	St. / Pc.		1000mm	RM	98,37
	H150mm					

Pure [®] Plus	Uitvoeringen Finitions Ausführungen Finishes	NL	FR	D	E
	VO	Verouderd ijzer	Fer vieilli	Dunkel Eisen	Aged Iron
	WB	Wit Brons	Bronze blanc	Weiss Bronze	White Bronze
	WBS	Mat Wit Brons	Bronze blanc satiné	Weiss Bronze satiniert	Satin White Bronze
	RB	Ruw Brons	Bronze brut	Rohe Bronze	Raw Bronze
	RM	Ruw Metaal	Métal brut	Rohes Metall	Raw Metal

Art°	Eenheid Unité Einheit Unit	REF.	€ excl. BTW hors TVA ohne MwSt. w/o VAT
------	-------------------------------------	------	---

	9393	St./Pc.	Kapstok Portemanteau Coat hook Garderobenhaken	VO	20,55
	9394	St./Pc.		WB	35,32
	15362	St./Pc.		WBS	35,32
	13840	St./Pc.		RB	35,32
	15361	St./Pc.		RM	20,55
	4				

	11966	St./ Pc	PT/Q	Haak Hook	VO	12,50
	11967	St./ Pc	PT/Q		WB	21,89
	15368	St./ Pc	PT/Q		WBS	21,89
	13843	St./ Pc	PT/Q		RB	21,89
	15367	St./ Pc	PT/Q		RM	12,50
	5					

	11964	St./ Pc	PT/R	Haak Hook	VO	12,50
	11965	St./ Pc	PT/R		WB	21,89
	15366	St./ Pc	PT/R		WBS	21,89
	13842	St./ Pc	PT/R		RB	21,89
	15365	St./ Pc	PT/R		RM	12,50
	6					

	11642	St./ Pc	PTT	Haak Hook	VO	17,22
	11643	St./ Pc	PTT		WB	24,86
	15364	St./ Pc	PTT		WBS	24,86
	13841	St./ Pc	PTT		RB	24,86
	15363	St./ Pc	PTT		RM	17,22
	7					

	10699	St. / Pc.	Handdoekring Porte serviettes Handtuchhalter Towel holder	VO	55,65
	10700	St. / Pc.		WB	70,49
	15360	St. / Pc.		WBS	70,49
	13819	St. / Pc.		RB	70,49
	15359	St. / Pc.		RM	55,65
	8				

Pure [®] Plus	Uitvoeringen Finitions Ausführungen Finishes	NL	FR	D	E
	VO	Verouderd ijzer	Fer vieilli	Dunkel Eisen	Aged Iron
	WB	Wit Brons	Bronze blanc	Weiss Bronze	White Bronze
	WBS	Mat Wit Brons	Bronze blanc satiné	Weiss Bronze satiniert	Satin White Bronze
	RB	Ruw Brons	Bronze brut	Rohe Bronze	Raw Bronze
	RM	Ruw Metaal	Métal brut	Rohes Metall	Raw Metal

	Art°	Eenheid Unité Einheit Unit	REF.	€ excl. BTW hors TVA ohne MwSt. w/o VAT
--	------	-------------------------------------	------	---

						
		left	right			
9	11835	St./Pc.	Single holder	150mm LEFT	VO	58,01
	9996	St./Pc.		150mm RIGHT	VO	58,01
	9995	St./Pc.		150mm LEFT	WB	85,66
	11836	St./Pc.		150mm RIGHT	WB	85,66
	15325	St./Pc.		150mm LEFT	WBS	85,66
	15326	St./Pc.		150mm RIGHT	WBS	85,66
	13808	St./Pc.		150mm LEFT	RB	85,66
	13811	St./Pc.		150mm RIGHT	RB	85,66
	15323	St./Pc.		150mm LEFT	RM	58,01
	15324	St./Pc.		150mm RIGHT	RM	58,01

						
		left	right			
	11829	St./Pc.	Single holder Square	150mm LEFT	VO	58,01
	11827	St./Pc.		150mm RIGHT	VO	58,01
	11830	St./Pc.		150mm LEFT	WB	85,66
	11828	St./Pc.		150mm RIGHT	WB	85,66
	15329	St./Pc.		150mm LEFT	WBS	85,66
	15330	St./Pc.		150mm RIGHT	WBS	85,66
	13812	St./Pc.		150mm LEFT	RB	85,66
	13813	St./Pc.		150mm RIGHT	RB	85,66
	15327	St./Pc.		150mm LEFT	RM	58,01
	15328	St./Pc.		150mm RIGHT	RM	58,01

						
		left	right			
10	9998	St./Pc.	Double holder	300mm	VO	62,14
	9997	St./Pc.		300mm	WB	96,41
	15332	St./Pc.		300mm	WBS	96,41
	13809	St./Pc.		300mm	RB	96,41
	15331	St./Pc.		300mm	RM	62,14

Pure [®] Plus	Uitvoeringen Finitions Ausführungen Finishes	NL	FR	D	E
	VO	Verouderd ijzer	Fer vieilli	Dunkel Eisen	Aged Iron
	WB	Wit Brons	Bronze blanc	Weiss Bronze	White Bronze
	WBS	Mat Wit Brons	Bronze blanc satiné	Weiss Bronze satiniert	Satin White Bronze
	RB	Ruw Brons	Bronze brut	Rohe Bronze	Raw Bronze
	RM	Ruw Metaal	Métal brut	Rohes Metall	Raw Metal

	Art°	Eenheid Unité Einheit Unit	REF.	€ excl. BTW hors TVA ohne MwSt. w/o VAT
--	------	-------------------------------------	------	---

						
	11839	St./Pc.	Double holder Square	300mm	VO	62,14
	11840	St./Pc.		300mm	WB	96,41
	15334	St./Pc.		300mm	WBS	96,41
	13810	St./Pc.		300mm	RB	96,41
	15333	St./Pc.		300mm	RM	62,14

						
11	11837	St./Pc.	Single holder	350mm LEFT	VO	58,01
	9999	St./Pc		350mm RIGHT	VO	58,01
	10000	St./Pc		350mm LEFT	WB	85,66
	11838	St./Pc		350mm RIGHT	WB	85,66
	15337	St./Pc		350mm LEFT	WBS	85,66
	15338	St./Pc		350mm RIGHT	WBS	85,66
	13814	St./Pc		350mm LEFT	RB	85,66
	13815	St./Pc		350mm RIGHT	RB	85,66
	15335	St./Pc		350mm LEFT	RM	58,01
	15336	St./Pc		350mm RIGHT	RM	58,01

						
	11831	St./Pc.	Single holder Square	350mm LEFT	VO	58,01
	11832	St./Pc		350mm RIGHT	VO	58,01
	11833	St./Pc		350mm LEFT	WB	85,66
	11834	St./Pc		350mm RIGHT	WB	85,66
	15341	St./Pc		350mm LEFT	WBS	85,66
	15342	St./Pc		350mm RIGHT	WBS	85,66
	13832	St./Pc		350mm LEFT	RB	85,66
	13833	St./Pc		350mm RIGHT	RB	85,66
	15339	St./Pc		350mm LEFT	RM	58,01
	15340	St./Pc		350mm RIGHT	RM	58,01

							
12			Toiletborstelhouder Porte-brosse wc Toiletburstenhalter Toiletbrush holder				
		10688		Set	BLACK POT	VO	103,67

Pure [®] Plus	Uitvoeringen Finitions Ausführungen Finishes	NL	FR	D	E
	VO	Verouderd ijzer	Fer vieilli	Dunkel Eisen	Aged Iron
	WB	Wit Brons	Bronze blanc	Weiss Bronze	White Bronze
	WBS	Mat Wit Brons	Bronze blanc satiné	Weiss Bronze satiniert	Satin White Bronze
	RB	Ruw Brons	Bronze brut	Rohe Bronze	Raw Bronze
	RM	Ruw Metaal	Métal brut	Rohes Metall	Raw Metal

Art°	Eenheid Unité Einheit Unit	REF.	€ excl. BTW hors TVA ohne MwSt. w/o VAT
------	-------------------------------------	------	---

			Toiletborstelhouder Porte-brosse wc Toiletburstenhalter Toiletbrush holde			
	10689	Set		WHITE POT	VO	103,67

			Toiletborstelhouder Porte-brosse wc Toiletburstenhalter Toiletbrush holde			
	10690	Set		WHITE POT	WB	129,11

			Toiletborstelhouder Porte-brosse wc Toiletburstenhalter Toiletbrush holde			
	10691	Set		BLACK POT	WB	129,11

			Toiletborstelhouder Porte-brosse wc Toiletburstenhalter Toiletbrush holde			
	15357	Set		WHITE POT	WBS	129,11

			Toiletborstelhouder Porte-brosse wc Toiletburstenhalter Toiletbrush holde			
	15358	Set		BLACK POT	WBS	129,11

			Toiletborstelhouder Porte-brosse wc Toiletburstenhalter Toiletbrush holde			
	13837	Set		WHITE POT	RB	129,11

			Toiletborstelhouder Porte-brosse wc Toiletburstenhalter Toiletbrush holde			
	13839	Set		BLACK POT	RB	129,11

Pure [®] Plus	Uitvoeringen Finitions Ausführungen Finishes	NL	FR	D	E
	VO	Verouderd ijzer	Fer vieilli	Dunkel Eisen	Aged Iron
	WB	Wit Brons	Bronze blanc	Weiss Bronze	White Bronze
	WBS	Mat Wit Brons	Bronze blanc satiné	Weiss Bronze satiniert	Satin White Bronze
	RB	Ruw Brons	Bronze brut	Rohe Bronze	Raw Bronze
	RM	Ruw Metaal	Métal brut	Rohes Metall	Raw Metal

Art°	Eenheid Unité Einheit Unit	REF.	€ excl. BTW hors TVA ohne MwSt. w/o VAT
------	-------------------------------------	------	---

			Toiletborstelhouder Porte-brosse wc Toiletburstenhalter Toiletbrush holder			
	15356	Set		BLACK POT	RM	103,67

			Toiletborstelhouder Porte-brosse wc Toiletburstenhalter Toiletbrush holde			
	15355	Set		WHITE POT	RM	103,67

			Pot			
	10683	St. / Pc.		BLACK POT		48,23
	10684	St. / Pc.		WHITE POT		48,23

			Brush without holder			
	10515	St. / Pc.		BLACK		29,31

						
	11644	St./ Pc	Prse square	Left	VO	14,93
	11646	St./ Pc	Prse square	Right	VO	14,93
	11645	St./ Pc	Prse square	Left	WB	24,42
	11647	St./ Pc	Prse square	Right	WB	24,42
	15303	St./ Pc	Prse square	Left	WBS	24,42
	15304	St./ Pc	Prse square	Right	WBS	24,42
	13844	St./ Pc	Prse square	Left	RB	24,42
	13845	St./ Pc	Prse square	Right	RB	24,42
	15301	St./ Pc	Prse square	Left	RM	14,93
	15302	St./ Pc	Prse square	Right	RM	14,93
H65mm ø 62mm	Eindsteen / Embout / Endstütze / End bracket					

Opgelet Attention Achtung Attention	holders) (pour supports singles) Bei Bestellung bitte angeben, ob es links oder rechts zeigend sein soll (für einzeln Halter) In case of order , pls. specify left or right side (only single holders)
--	---